



# ELEMENTS [VINYL] COMPLETE TECHNICAL GUIDE

**TG14A**

**INSTALLATION | MAINTENANCE | WARRANTY**

For the most accurate and updated information please check our online version at [www.my-nfp.com](http://www.my-nfp.com).





# ELEMENTS EXPEDITION COLLECTION INSTALLATION GUIDE

## EX EXPEDITION COLLECTION

INSTALLATION | MAINTENANCE | WARRANTY

Prop 65 Warning: Drilling, sawing, sanding, or machining wood products generates dust, a substance known to the state of California to cause cancer. Use caution during the removal or sanding of existing flooring or other building materials as these may contain hazardous fumes, chemicals, or generate harmful dust. Check the substrate for any health hazards. Always wear safety equipment and an approved dust mask.

For the most up-to-date installation, maintenance, and warranty requirements, please visit [www.my-nfp.com](http://www.my-nfp.com). All warranties are based off installation and maintenance guides published on our website at the time of installation.

The intended end user and the installer should have a clear understanding of the expectations of the color, installation, and layout. Carefully inspect the products before installation for any milling, dimensional, or visual defects. If the flooring supplied does not satisfy the customer, do not proceed with install. The decision not to proceed must be made within the first 10% or 100 sq ft, of the flooring boxes opened, whichever comes first; open boxes exceeding this amount will not be eligible for return.

### [01] GENERAL JOBSITE/HOME CONDITION

#### TO AVOID COSTLY INSTALLATION MISTAKES, ONLY INSTALL FLOORING IN ROOMS WITH ADEQUATE LIGHTING CONDITIONS.

Important: The requirements listed below are considered standard practices for the flooring industry and are required by most building codes. Following these simple guidelines will greatly extend the life of any fixture in the jobsite/home. Local building codes may vary and will prevail.

- It is the responsibility of the designated installer to inspect the flooring prior to installation. Inspect every plank for inconsistency with the finish, texture, milling, color, graining, tongue and groove integrity, and dimensions. Also, check the suitability of the flooring product to its environment. Flooring products installed with pre-existing defects, or that were incorrectly acclimated, CANNOT be claimed after installation.
- Verify there are enough materials to complete the job with a minimum of 2% or one box of extra (whichever is greater) for future plank replacements.
- Allow a minimum of 5% waste for culling, shipping damage, and on-the-job waste.
- Drainage from roofs, rain gutters, and other sources of moisture around the jobsite/home must be directed away from the site.
- If there is a crawl space make sure there is at least 18" clearance from the dirt to the bottom of the beams. Remove all cardboard from the concrete walls, pillars, and footings as it will trap and hold moisture. The entire crawl space must be covered with a minimum of 6 MIL plastic (puncture resistant) with all seams overlapped 18" and fully sealed with a moisture proof tape.
- To prevent excessive moisture buildup, all crawl spaces must have a minimum of 1.5 sq ft of ventilation for every 100 sq ft of crawl space at the exterior of the house for cross ventilation or an air exchanger will be needed. It may be necessary to install temperature/humidity activated exhaust fans to create air movement in the crawl space.
- All exterior doors, windows, drywall, painting, and venting must be properly installed prior to the delivery of the flooring to the jobsite/home. Do not store in exterior sheds, garages, or rooms that are not temperature controlled.
- All heating and cooling systems are required to be installed and functioning for at least 14

days before the installation begins.

- Use a hygrometer that reads temperature and RH (relative humidity) to check jobsite/home heating and cooling systems. They must be able to maintain a minimum of 30 to 60% RH and 60 to 85°F before and during the installation. Post installation, the temperature must be maintained between 60-85°F.
- Small humidifiers are not capable of properly maintaining the humidity levels in large jobsites/homes. Your local heating and cooling air service contractors can provide information for automatic humidifiers/dehumidifiers that work with your heating and cooling systems.
- Vinyl flooring is not recommended to be installed in any area of the jobsite/home that has extreme temperature and moisture fluctuations. For example: saunas, hot tub/pool rooms, green houses, exterior porches, or garages. The manufacturer does not warrant against these types of moisture related issues or related damages under their warranty.

### [02] IN-FLOOR RADIANT HEAT REQUIREMENTS (HYDRONIC SYSTEM ONLY)

Visit [www.my-nfp.com](http://www.my-nfp.com) for the current list of products that are approved for in-floor radiant heat. There are unique installation requirements for flooring installed over radiant heat. Prior to installation, it is the responsibility of the designated installer to check with the manufacturer for a current list of approved installation methods and underlayment requirements.

All warranties are based on installation and maintenance guides published on our website at the time of your installation.

#### IN-FLOOR RADIANT HEAT SYSTEM REQUIREMENTS:

- Only flooring that is clearly marked approved can be installed over in-floor radiant heat.
- Only hydronic in-floor radiant heat systems with fail safe capabilities (to ensure the boiler does not exceed 110°F and the surface temperature does not exceed 85°F) are approved.
- Operate the in-floor radiant heat system for at least 14 days prior to the flooring being installed. All moisture in the substrate MUST be evaporated off. This will also ensure all systems are in good running condition.
- To prevent expansion and contraction issues related to the in-floor heat system, a humidity control humidifier must be installed and properly functioning before, during, and after the installation.
- The in-floor radiant heat systems CANNOT be installed directly below the flooring. The heating element must be embedded at least 1/2" into the concrete, gypcrete, or installed under the wood subfloor. This will ensure the radiant heat is evenly distributed across the substrate before the heat comes into contact with the flooring.
- Important: Leave a 1/2" expansion gap around all walls, tubs/ shower, plumbing fixtures, exterior doors, large Sub-Zero style refrigerators or appliances.
- Transition strips/breaks are required over in-floor radiant heat substrates exceeding 35 feet lengthwise and widthwise.

#### IN-FLOOR RADIANT HEAT ACCLIMATION REQUIREMENTS:

- Do not deliver the flooring to the jobsite until all environmental conditions have been met.
- Acclimate for a minimum of 48 hours in the temperature controlled room where it will be installed.
- During acclimation, do not remove the material from the box or lean boxes on walls. Only stack the boxes squarely on top of each other, no taller than 3; and keep the stacks at least 3" apart.
- 48 hours prior to installation, set the temperature of the radiant heating system to 65°F; this setting must remain during install and 72 hours after install completion. The temperature of the radiant heat floor may be gradually increased 72 hours after installation, but the surface temperature should never exceed 85°F.
- To prevent the floor from overheating or trapping moisture, never cover the flooring before, during, or after installation with any type of non-breathable or excessively thick rugs, mats, solid surface items, plastic, or a mattresses laid directly onto the floor. The floor must be allowed to breathe.

### [03] IN-FLOOR RADIANT HEAT MOISTURE BARRIERS AND RETARDERS

The type of moisture barrier needed is usually based on the installation method and substrate. Different types of moisture barriers produce the same end result by doing it in different ways. Check with local building codes and the manufacturer of the radiant heat systems for recommendations.

## VINYL WITH ATTACHED CUSHION (IN-FLOOR RADIANT HEAT):

- Below, On, or Above Grade Concrete & Gypcrete Slabs: Cover the entire slab substrate with 6 mil plastic with all seams overlapping 12" and taped with moisture proof tape.
- Wood Subfloors: A moisture barrier is not required over a finished basement or crawl space that meets all of the "General Jobsite/Home Condition" requirements.

## [04] GENERAL INSTALLATION SPECS

- Avoid installing flooring planks pieces less than 8" in total length against walls or on ends. Stagger end joints no less than 8".
- It will generally be necessary to saw some flooring panels during installation. To obtain a clean cut, the pattern side should face down when using a jigsaw, saber saw, or circular handsaw and face up when you use a handsaw, table saw, or crosscut saw.
- Before installation begins, use a jamb saw to undercut all door casings (1/16" between door casing and top of flooring material) and vertical objects coming off the floor. To achieve the correct height, combine a piece of the vapor retardant and flooring together to use as a guide for the saw. Be sure to clean out all debris from under the jambs. This will allow the flooring to slide underneath the object for a clean, professional look.
- Contractors: When setting door casings post-installation, make sure there is adequate space for the flooring material to expand and contract without any hindrance.
- Never fasten nails/screws anything through the flooring into the substrate. The floor must be allowed to float freely.
- Do not caulk the floor to any permanent or fixed object. The floor must be able to float freely.

## [05] GENERAL SUBSTRATE CONDITIONS

- All substrates must be flat, structurally sound, and free of dust, loose particles, paint, and drywall compound.
- Sand and/or flatten the substrate to within 3/16" dip or rise in 10' or 1/8" dip or rise in 6' radius.
- If leveling of the substrate is required, use only cement-based leveling compounds. Be sure to follow the leveling compounds manufacturer installation guidelines.
- To prep or flatten the substrate, you can use a hand-held angle grinder with special cupped diamond grinding wheels and vacuum attachments. It can be rented or purchased from your local rental or home building center. This system works well with any type of substrate. Use precautions when sanding any surface, check the substrate out for any health hazards, and always wear safety equipment and approved dust masks.
- Vinyl flooring can be installed over wood subfloors that are ON or ABOVE GRADE; vinyl flooring can be installed over concrete or gypcrete substrates that are BELOW, ON, or ABOVE GRADE.
- The substrate, when walked on, must not exceed 1/4" deflection in a 6' radius, or more than a 1/16" between the floor joist. If it does, this condition must be corrected before any product installation begins. The subfloor will not stiffen up after the flooring is installed (See approved substrates).
- Always check and repair any loose, delaminating, or broken substrates.

## [06] APPROVED SUBSTRATES

### PLYWOOD/OSB:

- Do not install over wood subfloors that test above 12% MC (moisture content).
- Note: If installing new wood subfloors from lumber yards, be sure to test the MC. Typically, they have higher levels of moisture and may need to acclimate longer.
- Fix all squeaks coming from the wood subfloor prior to installation. Use wood screws, a minimum of 2-1/2" long, fastened every 6" through the wood subfloor into the joist. Squeaks in the subfloor will not go away after the floor has been installed.
- The acceptable minimum thickness of the wood subfloor is determined by the distance between the joists/trusses. Vertical deflection must be under 1/4" in a 6' radius when walked across.
  - When joists are 16" o/c or less, the minimum acceptable thickness is 5/8" CDX plywood or nominal 3/4", OSB 40LB Minimum density, T&G, with a TECO or APA certification stamp.
  - When joists are 16" o/c up to 19.2" o/c, the minimum acceptable thickness is 3/4" plywood or nominal 3/4", OSB 40LB Minimum density, T&G, with a TECO or APA certification stamp.
  - When joists are 19.2" o/c up to 24" o/c, the minimum acceptable thickness is 1" plywood or nominal 1 1/8", OSB 40LB Minimum density, T&G, with a TECO or APA certification stamp.

**ABOVE GRADE CURED CONCRETE/GYPCRETE: 6 MIL PLASTIC VAPOR BARRIER IS RECOMMENDED TO AVOID MOISTURE RELATED ISSUES.**

**BELOW/ON GRADE CURED CONCRETE/GYPCRETE: A 6 MIL PLASTIC VAPOR BARRIER OVER LAPPED 12" AND TAPED WITH MOISTURE PROOF TAPE IS REQUIRED. FAILURE TO ADHERE TO THIS REQUIREMENT WILL VOID ALL**

## MANUFACTURER WARRANTIES

- Cured concrete must be over 3000 PSI. Cured gypcrete must be over 2500 PSI.
- All concrete or gypcrete substrates must be cured for a minimum of 60 days before any flooring product is installed over them.
- Concrete moisture testing should be performed by ASTM F1869 Calcium Chloride Tests with levels NOT exceeding 5LBS per 1000 ft<sup>2</sup> for a 24 hour period, or an ASTM F2170 In-Situ relative humidity test with readings exceeding 80%.
- Gypcrete dries very fast so Maxxon recommends using the mat test or Delmhorst #B2100 moisture meter.
- Test the concrete subfloor for alkalinity. The pH of the floor should be between 5 and 9.

## PARTICLE BOARD (UNDERLAYMENT-GRADE):

- The only manufacturer recommended installation method that can be used directly over underlayment-grade particle board is the floating method, as long as there are no current or future moisture concerns from below or above. If moisture comes in contact with the particle board, it may swell. The product warranty does not cover subfloor upheavals.

## OTHER APPROVED SUBSTRATES (FLOATING ONLY--ALL MOISTURE CONTENT, FLATNESS AND DEFLECTION REQUIREMENTS WOULD APPLY.)

- Ceramic, porcelain, or natural tile with the grout joints filled flat with Portland based patching material.
- Single layer of clean, well adhered, non-cushioned, full spread glue sheet vinyl or VCT. All embossing must be feathered and filled with suitable filler patching compound.

## UNACCEPTABLE SUBSTRATES:

- Solid or engineered wood floors over concrete or with any texture.
- Floors that are floating, cushioned, perimeter glued, carpet, carpet pad, lumber subfloor, additional cushions or underlayment, or subfloors that are sticky.
- ACQ treated plywood or exterior low density OSB sheathing used for general construction.

## [07] ACCLIMATION (FOR RADIANT HEAT SEE "IN-FLOOR RADIANT HEAT ACCLIMATION REQUIREMENTS" SECTION)

- Installing flooring before it has properly acclimated will greatly increase the chances of expansion and contraction issues and may make it more difficult to install.
- Do not deliver the flooring to the jobsite until all environmental conditions have been met.
- Acclimate for a minimum of 48 hours in the temperature controlled room where it will be installed.
- During acclimation, do not remove the material from the box or lean boxes on walls. Only stack the boxes squarely on top of each other, no taller than 3', and keep the stacks a minimum of 3" apart.
- During installation floor temperature should be within 65-80°F.
- Never cover the flooring before, during, or after installation with any type of plastic or tar paper. It must be allowed to breathe. Use only breathable floor protective construction paper (FortiBoard) to protect the flooring.
- Propane heaters are not an approved source of heat and can give off extreme amounts of moisture. They also do not provide a reliable and consistent source of heat. In fact, for every gallon of propane or kerosene that is burned, they will put approximately 1.1 gallons of moisture into the ambient space. The manufacturer warranty will be void if the jobsite/ home heating and cooling system were not fully operational at the time of installation.

## [08] EXPANSION REQUIREMENTS

- Leave a minimum of 1/4" expansion gap for all installations under 20' lengthwise or widthwise. For installations exceeding 20' lengthwise or widthwise, add 1/16" per additional 5' of length or width, up to 5/8". For example: 25 linear feet would require a 5/16" expansion gap.
- Transition strips/breaks are required on installation exceeding 50 feet length or width; and for installations over in-floor radiant heat, transition strips are required if exceeding 40 linear feet.
- Never install cabinetry, islands, or other permanent fixtures on top of a floated floor.
- Never use nails to secure anything to the floor. The floor must be allowed to float.
- Leave the required expansion gap around all walls, tubs/ shower, plumbing fixtures, large Sub Zero style refrigerators, exterior doors, etc.
- Once the floor installation is complete, remove all spacers that were used to maintain the expansion gap.
- Heavy furniture (500 lbs or more) may obstruct the free, natural movement of a floated floor. Restricting this movement in certain areas can lead to problems such as buckling or separation when the floor experiences natural expansion and/or contraction.

## [09 FL] APPROVED FLOATING METHOD (ELEMENTS 2G ANGLE/ANGLE SYSTEM)

The 2G Angle/Angle system is a patented locking profile for installing flooring planks without using glue.

### FLOATING METHOD TIPS:

- The panels are clicked together on the short side until the row is completed then the entire row is engaged on the long side.
- Be sure to inspect all edges and remove debris from the click before installing.
- Either side of the panels are engaged at an angle of 20 to 30° to the panel already installed. Move the panel gently up and down while exerting forward pressure. The panels will automatically click into place. Then lay the plank down to the floor.
- As you install the click flooring, ensure all seams are fully engaged before moving on to the next row. Visually, a row can appear to be engaged but is not. To avoid this, use an approved tapping block to tap the short side then the long side of the planks together. This will securely engage the locking system.

## [10] HOW TO PROTECT THE FLOOR DURING & AFTER INSTALLATION

- After each section of flooring has been installed and thoroughly cleaned, cover the floor with a breathable construction paper (FortiBoard). Do not apply the tape directly to the surface of the flooring, as it may damage the finish.
- During construction, vacuum the floor as often as it takes to keep the floor free of dirt and construction debris. Never use a beater brush.
- If drywall repairs or any type of sanding is needed, thoroughly cover the floor. These types of dust and grit can damage the floor's finish and are very difficult to remove if it gets into the joints. Do not wet mop these types of dust. Always use a vacuum without a beater brush to remove any construction dust if needed.
- Before furniture goes onto the new floor, apply approved 3/16" thick heavy-duty felt pads under all furniture feet.
- Furniture with metal or hard plastic rollers or casters are NOT APPROVED for use on Vinyl flooring.
- Never roll or drag anything heavy over the new floor. It will make indentations or scratches in the surface. Always use a soft-tire dolly when moving objects or a carpet piece turned upside-down or an air-sled.

## FLOATING INSTALLATION

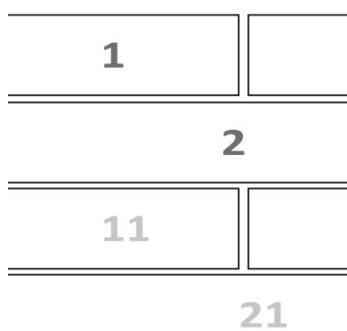

### NOTE:

Products should be staggered in a bricklaid pattern. Stagger equal to half of a plank for the first four rows, and randomly from row 5 on. Tools needed: pull bar, spacers, soft-faced hammer, and tapping block.

### STEP 1

Leave a minimum of 1/4" expansion gap for all installations under 20 linear feet and add 1/16" per additional 5' of length for installations exceeding 20 linear feet. For example: 25 linear feet would require a 5/16" gap. The maximum continuance distance without t-mold transition is 50' width or length. Insert spacers to create proper expansion gaps at ends and edges where the planks will meet the walls and any vertical objects.

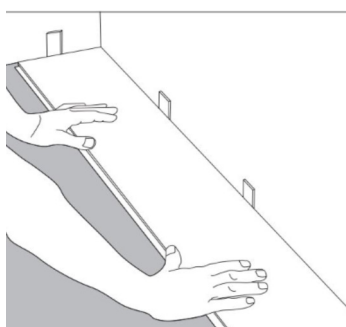

### STEP 2

Start the first row by inserting the short end of the plank (tongue first) into the groove at an 20 to 30° angle, then rotating downward to lock it in place. Continue laying planks to establish the first row.

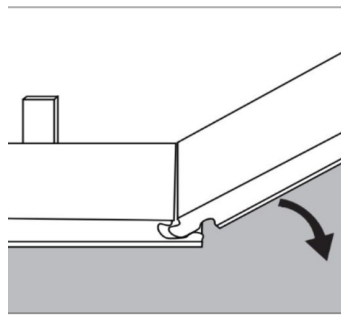

### STEP 3

Use a cut piece to start the second row. NOTE: End joint spacing must be at least 8" for all adjacent rows.

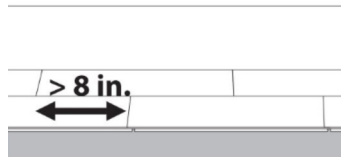
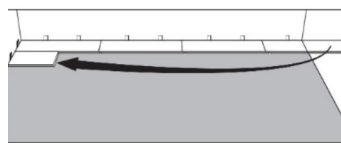

### STEP 4

For additional rows, engage the locking system on the short side of the last plank installed by inserting the tongue at a 20 to 30° angle, then rotating downward. Slide this plank toward the long side of the previously installed plank, then engage the long side of the plank. Lift the other side up slightly, and push or pull the plank together until it clicks together.

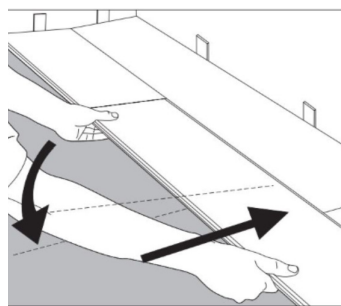

### STEP 5

Use a scrap piece of flooring as a tapping block and tap on the long edge of the plank to ensure that the locking system fully engages.

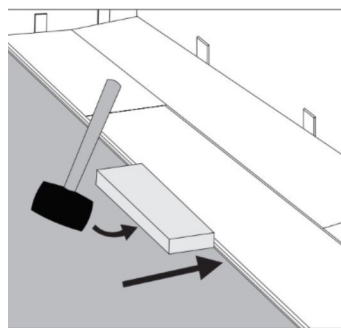

### STEP 6

Use a cut piece to start the second row. NOTE: End joint spacing must be at least 8" for all adjacent rows.

Using a scrap piece (with a factory end joint) as a tapping block, tap the end of the plank to engage the locking system. Be cautious to not damage the locking profile when tapping. Continue installing until you reach the end of the row.

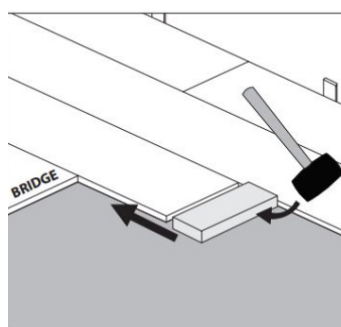



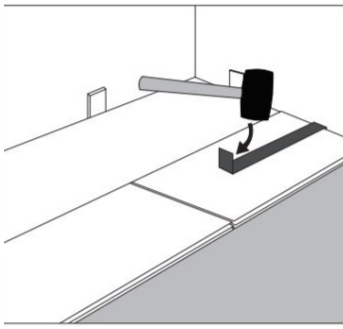

## STEP 7

At the end of the row, use a hammer and pull bar to engage the locking system of the final piece in the row. Install a spacer at the row end. Repeat this process until the final row of flooring. At the final row, use the hammer and pull bar to lock the long edges of the planks as well as the row ends. When completed, pull all spacers and double check to ensure there is the required expansion gap.

# CARE AND MAINTENANCE GUIDE

Please thoroughly review all care and maintenance guides before the new flooring is cleaned. Using the wrong type of floor cleaner can severely damage the floor's finish. These guides can be found online at [www.my-nfp.com](http://www.my-nfp.com)

## GENERAL MAINTENANCE:

- The predominant cause of damage to a floor's finish is abrasion from dirt and grit. It is important to use walk off mats at entrances and doorways and non-staining floor protectors under heavy furniture, chairs, and tables.
- Visit [www.rugpadusa.com](http://www.rugpadusa.com) for rug cushions. Use rugs that are made specifically for vinyl floors. Shake them out regularly. Place rugs in any area where water is in use, such as sinks or a pet's water dish.
- To prevent the floor from overheating or trapping moisture, never cover the flooring before, during, or after installation with any type of non-breathable or excessively thick rugs, mats, solid surface items, plastic, or a mattresses that is laid directly onto the floor. It must be allowed to breathe.
- Always apply heavy-duty felt furniture pads (at least 3/16") to all furniture feet.
- Metal and hard plastic casters are not approved for use on Vinyl floors and may void your warranty.
- Over time, floors may begin to lose their brilliance and require an application of floor polish. Frequency and location will depend on the traffic the floor undergoes. A good quality floor polish like "Hilway Direct" can provide up to a year of protection in high traffic areas. Please visit [www.hilway.com](http://www.hilway.com) for information.
- Oil or petroleum-based products can stain flooring surfaces. Do not track asphalt-driveway sealer, motor oil, wood stains, or similar products onto the vinyl floor covering.
- Any flooring may become slippery when wet. Immediately wipe up wet areas from spills and be careful walking on any newly cleaned floor while it is wet.
- Never use a steam mop as temperatures exceed the temperature allowed for Vinyl.

## PET GUIDE:

Protecting the beauty of your floor can be easy, even with pets. Follow these simple guidelines to keep your flooring in good condition while having indoor pets.

- Clip your pet's nails regularly. If you can hear the nails clicking on the floor, they need to be trimmed.
- Wipe up any pet waste/vomit as quickly as possible. These accidents, if not properly cleaned up or left for long periods of time, can damage the finish.
- It is recommended to use natural fiber rugs or a riser to keep water bowls off the floor.
- If your pets are hyper and like to run and slide across the floor, it is recommended to place rugs in these areas to protect the floor

## APPROVED CLEANING METHODS:

- Vacuum (WITHOUT A BEATER BRUSH), dry mop, or sweep your floor at least once a week or more if needed. Do not let sand, dirt, or grit build up. It will act like sandpaper and abrade and dull the finish. ZEP Neutral pH Floor Cleaner applied with microfiber pads with a terry cloth cover is the recommended way to clean your floor. The best method of removing dirt and grit is vacuuming with a soft brush attachment on your vacuum.

- After all dirt and grit particles have been removed (using a vacuum, dry mop, or broom) lightly spray a mist of the cleaner over a 4' x 6' area of your floor or directly on the cleaning cloth. Thoroughly clean the floor surface and dry if needed. Finish one area before moving onto the next. Repeat the process until the floor is clean. When the ZEP cleaning cloth becomes soiled, rinse with water, thoroughly wringing out the cloth. Once the cleaning cloth becomes excessively soiled, launder and reuse. Excessively soiled cleaning cloths will cause streaking and can abrade the floor. Cleaning vinyl flooring with any type of wood polishes, Murphy's Oil Soap, Mop & Glo, furniture polishes, acidic
- cleaners (ammonia/bleach) will damage the finish and will void the manufacturer warranties. Always follow the installation and maintenance located on our website.

**DO NOT USE A VACUUM WITH A BEATER BRUSH. DO NOT USE RUBBER BACKED OR NON-VENTILATED RUGS. THESE TYPES OF RUGS CAN TRAP MOISTURE OR STAIN THE FINISH AND CAN SEVERELY DAMAGE THE FLOOR.**

# LIMITED-LIFETIME WARRANTY INFORMATION

All National Flooring Products Elements Vinyl lines have a manufacturer limited lifetime structural warranty and limited lifetime warranty. Some clearly marked products are approved for 10 year light commercial limited warranty.

## WHO IS COVERED?

- All warranties outlined in this Limited Warranty are given solely to the original retail purchaser (end-user) of the product. For the warranty to take effect, the flooring must be paid for in full, installed and maintained correctly, and only used for its intended purpose.
- Vinyl products purchased online from Internet retailers are not covered under this warranty, since there is no way to validate the handling, storage, shipping, installation, or sales practices of the source.
- Starting February 1st, 2020, all new National Flooring Products installations must be registered online within 60 days in order to file a claim.

**REGISTER AT [WWW.MY-NFP.COM](http://WWW.MY-NFP.COM) UNDER THE "REGISTER MY FLOOR" TAB**

## WHAT IS COVERED?

- The limited warranties are subject to the Elements Vinyl flooring applications, limitations, disclaimers, and exclusions described below and are effective for floors purchased after February 1st, 2020. All warranties begin from the date of retail purchase.
- Moldings (materials ONLY) are covered under this limited warranty for 1 year from date of installation.

## TERMS OF MANUFACTURE WARRANTY

- Warranty durations and types will vary depending on the flooring products purchased. Please see the specific warranty found on every sample label or [www.my-nfp.com](http://www.my-nfp.com) for warranty duration. All warranty claims must be received in writing. The term of warranty is based on the receipt date of the purchase. All credits or replacement material will be arranged by the manufacturer.

## RESIDENTIAL USE (LIMITED LIFETIME WARRANTY)

- Year 1: Repair or replacement of faulty material with labor up to maximum labor rate, if professionally installed by a licensed installer, and all installation requirements were fully met.
- Year 2: Repair or replacement of faulty material with 50% of labor up to maximum labor rate, if professionally installed by a licensed installer, and all installation requirements were fully met.
- Years 3-4: Repair or replacement of faulty material with 25% of labor up to maximum labor rate, if professionally installed by a licensed installer, and all installation requirements were fully met.
- Years 5+: Repair or replacement of faulty material only, if professionally installed, and all installation requirements were fully met. The percentage covered will be prorated after the 4th year. For example, for a professionally installed product, that is covered by a Limited Lifetime warranty, the manufacturer will repair or replace 5/25th (or 80%) of the defective product only.

## LIGHT COMMERCIAL USE (LIMITED 10 YEAR WARRANTY)

- Year 1: Repair or replacement of faulty material with labor, up to maximum labor rate, if professionally installed by a licensed installer, and all installation requirements were fully met.
- Year 2: Repair or replacement of faulty material with 50% of labor, up to maximum labor rate, if professionally installed by a licensed installer, and all installation requirements were fully met.
- Years 3-4: Repair or replacement of faulty material only, if professionally installed, and all installation requirements were fully met
- Years 5-10: Repair or replacement of faulty material only, if professionally installed, and all installation requirements were fully met. The percentage covered will be prorated after the 4th year. For example, for a professionally installed product, that is covered by a Limited 7-year warranty, the manufacturer will repair or replace 5/10th (or 50%) of the defective product only.

## STRUCTURAL

- We warrant to the original retail purchaser that the flooring in its original manufactured condition will be free from defects in lamination and assembly for the warranty period.

## FINISH

- We warrant to the original retail purchaser that the wear layer on the surface of the flooring planks will not wear through or separate from the core under approved residential or commercial use, when maintained in accordance with the recommended installation and maintenance guidelines for the length of the warranty (ex. 3-year, 25-year, lifetime). "Wear layer" is defined by the total thickness of the top 20 mil protective layer. "Wear through" is defined as a complete loss of this finish wear layer, so that the printed décor film itself is affected and exceeds 2% of the installed area. Gloss reduction, indentation, scratches, and/or dull appearance are not considered a product defect or surface wear. The Elements Vinyl care and maintenance guidelines provided online at [www.my-nfp.com](http://www.my-nfp.com) are not intended to be an exclusive list. Please note, floors with a high gloss finish will tend to show scratches and dents more easily. These types of wear are considered normal.

## QUALITY ASSURANCE

- The manufacturer warrants to the registered purchaser of our flooring products that the floor will meet the manufacturer quality standards. The intended end user and the installer should have a clear understanding of expectations of the color, installation, and layout. Carefully inspect the products before installation for any milling, dimensional, or visual defects. Since Vinyl is imitating a natural product, there will be natural variations in color, tone, texture, and graining that are not covered by this warranty. Flooring color variations, or darkening, are a natural occurrence and may be due to exposure to sunlight or natural aging. The samples may not always exactly match the actual flooring received. Inherent variations in grain or color are not considered as manufacturing defects. This pre-installation warranty expires upon installation.

## TERMS OF LIMITED LIFETIME WARRANTY:

- Within one year: For claims on defects of this product, as covered by this warranty, reported in writing within one year of purchase, National Flooring Products will arrange a credit based on the original purchase of the product or replace the product. Reasonable labor costs are included.
- Between year One - Five: For claims on defects of this product, as covered by this warranty that are reported in writing after one year but within five years of purchase, National Flooring Products will arrange a credit based on the original purchase of the product or replace the product. National Flooring Products will pay 50% of reasonable labor costs.

## WHAT ARE THE CONSUMER'S RESPONSIBILITIES UNDER THIS WARRANTY?

- You must register your new floor at [www.my-nfp.com](http://www.my-nfp.com) within the first 60 days after installation. The manufacturer may request proof of pre-installation moisture documentation from you when submitting a claim under this warranty. The manufacturer strongly advocates the use of licensed, experienced installers for best results. If using a professional wood flooring licensed installer, you may be asked for the name and license number when submitting a claim.
- The installer must thoroughly inspect every flooring plank in each carton before permanent installation. The manufacturer is not responsible for any labor or damages incurred by delivery delays, flooring product not matching the samples, wrong product installed, dye lot (mismatch),

- installation, or jobsite conditions. The installer/owner is the final inspector and assumes the responsibility to determine if the product is correct and acceptable before installation begins.
- To ensure repairs can be made in the future, it is required that a minimum of 2%, or one whole box (whichever is greater) of the floor be kept in unopened boxes in a temperature-controlled room. This 2% or the one box can be used by the manufacturer for plank replacement as needed.
- The flooring must have been installed in accordance with all manufacturer installation guidelines.
- A minimum of 5% extra material should have been added for waste factor to the actual footage needed as allowance for product culling, cutting, waste, and mismanagement.
- Maintenance must be properly performed as needed in accordance with the manufacturer care and maintenance.

## WHAT IS THE MANUFACTURER'S RESPONSIBILITY UNDER THIS WARRANTY?

- PRE-INSTALLATION - Should the material be doubtful as to grade, manufacturing, texture, color, graining, dye lot, and factory finish, or have excessive shipping damage, those defective materials shall not be more than 5% of total material. If the manufacturing defects exceed 5%, the manufacturer will supply additional material for replacement and cover standard shipping fees to the retailer.
- If any of the covered events occur within the warranty period, the manufacturer will furnish another comparable flooring that it manufactures (of similar pricing, specifications, and quality) for either the repair or the replacement flooring material of the defective area, at the manufacturer's sole discretion. Vinyl floors that were installed correctly will be eligible for labor cost reimbursement up to \$2.49 per square foot of the installed area. If the floors were installed incorrectly by a non-licensed installer, the manufacturer assumes no responsibility for any labor cost associated with such repairs or replacement. In the event that we are unable to correct the problem after a reasonable number of attempts, or if the replacement or repairs fail in the same manner a second time, we will refund the wholesale portion of the purchase price for the section of failed flooring.
- These warranties do not cover removal or replacement of cabinets, electrical fixtures, plumbing fixtures, handrails, transitions, moldings, furniture, or any other fixtures of the jobsite/home. These are the exclusive remedies under this warranty if a defect or other warranted condition occurs. We reserve the right to verify any claims or defect by inspection and have samples removed for technical analysis.

## WHAT IS NOT COVERED UNDER THIS WARRANTY?

- Damage caused by fire, flooding, and other natural disasters.
- Damage caused by negligence, accidents, misuse, abuse, or man-made disasters.
- Damage caused by vacuum cleaner beater brush or hard heads.
- Damage caused by appliances, furniture, and casters.
- Damage caused by cutting from sharp objects, tape, adhesive, or burns.
- Damage caused by the use of NON-APPROVED cleaning products or methods such as: wax, wood polish, alkaline products, any abrasives, wet or steam mopping, etc.
- Construction or installation related damage. (Examples: chips, dents, scratches, etc.)
- Reduction in gloss, scratches, or indentation due to sand, pebbles, other abrasives, pets, insects, construction traffic, or failure to maintain the floor as required.
- Reduction in gloss or any finish distortion from removing any adhesives or chemicals.
- Mold or mildew growth from over cleaning, steam mops, leaking pipes or any other water sources.
- Color, shade, or texture variations between samples or replacement flooring and the actual material.
- Product warping, buckling, or cupping due to any water related occurrence (floods or extreme wet mopping).
- Fading or color change due to UV rays from direct sunlight.
- Deficiencies related to subfloor/floor joist assemblies, subfloor preparation materials, and fasteners including, but not limited to, uneven subfloor surfaces, floor deflection, or voids in the subfloor.
- Noises (squeaking, popping, crackling, etc.) associated with subfloor movement.
- Naturally occurring characteristics such as variations in the printed layer/film, graining, color, mineral streaks, and knots.
- Seasonal gapping caused by natural expansion and contraction resulting in separation between boards, or damage caused by low or excessive humidity.
- Floors installed in rooms with extreme direct sunlight or external heat sources where the surface temperature of the floor drops below 60°F or exceeds 85°F.
- Floors damaged from in-floor radiant heat, from the use of rugs, mats, or mattresses laid directly on the floor, or any solid surface item that causes the floor to overheat.
- Floors installed over substrates with excessive moisture (MC/RH), and/or installed without an

approved moisture barrier/retarder.

- Floors installed with NON-APPROVED adhesives. All bond and moisture related warranties come solely from the manufacturer of the adhesive and moisture retarders. The manufacturer of the flooring is not liable for bonding or moisture related warranted failures.
- Floors installed with NON-APPROVED underlayment or padding. All padding, vapor barriers, and underlayment must be specifically approved for use under Elements Vinyl floors.
- Floors installed over in-floor radiant heating systems that were not approved. The in-floor radiant heating system must meet all requirements specified in the Elements Vinyl manufacturer installation guidelines. Gapping between boards may occur on any plank flooring installed over an in-floor radiant heating system and is not considered a defect.
- Floors damaged caused by in-floor heating element not embedded minimum of 1/2" into the substrate.
- Damage caused from excessive moisture coming from any source that exceeds the substrate/subfloor maximum moisture content levels set by the manufacturer in this guide.
- Motorized wheeled objects or wheelchairs Exceeding total 300 pounds of rolling weight, which are not covered under the terms of this warranty.
- Heavy furniture (500 lbs and over) may obstruct the free, natural movement of a floated floor. Restricting this movement in certain areas can lead to problems such as buckling or separation when the floor experiences natural expansion and/or contraction.
- Floors damaged, or adhesive breakdown caused by subfloor moisture or water damage, including damage due to broken or leaking water pipes, ground moisture, flooding, wet mopping, steam mopping, damage, or unapproved cleaning agents.
- Installation defects, including but not limited to, installations made: (i) upon improper acclimation; (ii) in violation of applicable state or local housing or building codes, or (iii) by non-licensed installers, (iv) contrary to written instructions furnished with the product.
- The warranty does not apply to products designated as "BARGAIN," "CABIN GRADE," "SECONDS," "CLOSEOUT," "DISCONTINUED," OR "NON-STANDARD." SUCH PRODUCTS ARE SOLD "AS IS."

## COMMERCIAL INSTALLATIONS, UNLESS OTHERWISE NOTATED PRE-INSTALLATION. APPROVED COMMERCIAL INSTALLATION TYPES ARE AS FOLLOWS:

### SCHOOLS

- Training & Meeting Room, Common Area.

### MEDICAL FACILITY:

- Storage Room, Waiting Room, Patient Room,
- Examination Room

### RETAIL:

- Product Display Area, Boutique, Sales Floor, Showroom,
- Hair Salon (excluding damages to finish caused by chemicals)

### HOTELS:

- Conference/Meeting Rooms, Bathrooms

### OFFICES BUILDINGS:

- Office, Conference/Meeting Room, Showroom, Dining Room, Break Room, Hallways

## EXCLUSIONS FROM THIS WARRANTY INCLUDE

- YOUR EXCLUSIVE REMEDY AND THE MANUFACTURER'S SOLE LIABILITY FOR ANY CLAIM, WHETHER IN TORT, CONTRACT, OR BREACH OF WARRANTY, SHALL BE LIMITED TO THE REPAIR, REPLACEMENT, OR REFUND OF THE APPLICABLE PURCHASE PRICE OF THE DEFECTIVE GOODS AS SPECIFIED HEREIN. IN NO EVENT AND FOR NO CAUSE WHATSOEVER, INCLUDING ANY BREACH OR DEFAULT BY NEGLIGENCE, SHALL THE MANUFACTURER HAVE ANY OTHER LIABILITY (INCLUDING, WITHOUT LIMITATION, INCIDENTAL, CONSEQUENTIAL, OR PUNITIVE DAMAGES) OR ANY MONETARY LIABILITY TO YOU IN EXCESS OF THE CONTRACT PRICE OR PRICES OF THE PERTINENT PRODUCTS IN QUESTION.
- FOR CERTAIN PRODUCTS, ANY OR ALL DISPUTES ARISING OUT OF MANUFACTURER'S TUFFCORE FLOORING PRODUCTS OR THIS WARRANTY SHALL BE SUBJECT TO MANDATORY AND BINDING ARBITRATION IN LOS ANGELES, CALIFORNIA, PURSUANT TO THE RULES OF THE AMERICAN ARBITRATION ASSOCIATION. ANY TRIALS BY JURY ARE EXPRESSLY WAIVED.
- THIS WARRANTY DOES NOT APPLY TO DISCONTINUED ITEMS, CLOSE OUT ITEMS, OR ITEMS SOLD "AS IS." ALL SUCH PRODUCTS ARE SOLD "AS IS" AND SHALL NOT HAVE ANY WARRANTY OF ANY KIND, INCLUDING, BUT NOT LIMITED TO, ANY EXPRESS WARRANTIES, IMPLIED WARRANTIES, WARRANTIES OF MERCHANTABILITY (EXPRESS OR IMPLIED), WARRANTIES OF FITNESS FOR A PARTICULAR PURPOSE (EXPRESS OR IMPLIED), OR ANY OTHER WARRANTIES REQUIRED BY LAW OR FACT.
- SOME JURISDICTIONS DO NOT ALLOW EXCLUSION OR LIMITATIONS OF INCIDENTAL OR CONSEQUENTIAL DAMAGES, OR LIMITATIONS ON HOW LONG THE IMPLIED WARRANTY LASTS, SO THE ABOVE LIMITATIONS OR EXCLUSIONS MAY NOT APPLY TO YOU.

- THESE WARRANTIES GIVE YOU SPECIFIC LEGAL RIGHTS, AND YOU MAY ALSO HAVE OTHER RIGHTS THAT VARY BY JURISDICTION.
- NO RETAILER, DISTRIBUTOR, MANUFACTURER, EMPLOYEE, OR SALES AGENT REPRESENTATIVE HAS THE AUTHORITY TO ALTER THE OBLIGATIONS, LIMITATIONS, DISCLAIMER, OR EXCLUSIONS UNDER ANY OF OUR WARRANTIES. WE EXCLUDE AND WILL NOT BE LIABLE FOR INCIDENTAL, CONSEQUENTIAL, OR SPECIAL DAMAGES UNDER OUR WARRANTIES. MEANING ANY LOSS, EXPENSE, OR DAMAGE OTHER THAN TO THE FLOORING ITSELF THAT MAY RESULT FROM A DEFECT IN THE FLOORING WILL NOT BE COVERED. OUR LIMITED WARRANTIES CONSTITUTE THE ONLY EXPRESSED WARRANTIES FOR THE PRODUCT PURCHASED.

## WHAT SHOULD THE CONSUMER DO IF THERE IS AN ISSUE WITH THEIR TUFFCORE FLOOR?

In the event of a claim, please contact the retailer where the flooring products were purchased. The retailer will fill out all claim forms and notify National Flooring Products. Claims may take up to 60 days to process. A National Flooring Products representative will contact the homeowner to schedule any inspections and repair work if the manufacturer deems the claim is warranted. This could include but may not be limited to hiring a Certified Inspector. Certified Inspectors are independent of any mills, distributors, dealers, or cleaning companies to give an unbiased evaluation of any floor conditions. If an inspector deems the floors claim warranted, they will typically give a remedy on how to fix the floor. The manufacturer will strongly consider the inspectors suggestion or remedy. Please keep all your product registration, pre-installation, and post-installation receipts including but not limited to your sales receipt, pre-installation moisture test, photos, installer's name, phone number, and license number. Information regarding the claimed defect, date, and proof of purchase must be provided.

## PRODUCT DISCLAIMER









Real wood flooring is a natural product with resulting variations in graining, hardness, color, tone, sheen levels, and texture. Vinyl Vinyl and Laminate products are made to look like wood flooring and are manufactured to resemble natural products with the same variations in graining, color, tone, sheen levels, and texture. National Flooring Products has attempted to provide reliable representation all of its products and their features but cannot be held liable for these variations. National Flooring Products has provided pictures as a courtesy to our customers; and due to the nature of photography and digital representations, we cannot guarantee that the physical product will look exactly like the pictures, or images contained within the website or on any printed media. It is recommended to obtain an actual sample of the product prior to ordering. It is the customer's responsibility to inspect all flooring prior to installation for any visible natural variations or pre-installation manufacturer defects. Installations of the flooring with any visible defects constitutes acceptance of these defects and cannot be claimed under any warranty after installation. All warranties are provided solely by the manufacturer of the product, not all products are manufactured by National Flooring Products. In the event of a claim, National Flooring Products customer service team will assist the customer, but it is ultimately between the customer and the manufacturer to resolve. All transitions, vents, stair treads, and risers have a one-year finish manufacturer warranty from the date of purchase. Any transitions, vents, or special items that are installed or altered in any way are not eligible for return or credit. All sales of special-order items are final.

## GENERAL DISCLAIMER

National Flooring Products has attempted to the best of its ability to provide accurate information on all marketing media and informational documents. To our knowledge, the information contained within the website and all published documents are correct. By exploring and using this information, you agree not to hold National Flooring Products liable for using this information. National Flooring Products shall in no way be held liable for any damages resulting from, coming out of, or in relation to the use of the information. Pictures and related documents may contain technical inaccuracies or typographical errors. National Flooring Products reserves the right to make changes, additions, and removal of any documents, information, or graphics in this website at any time without notice. All information provided on this website is copyrighted and may not be reproduced without written consent. © 2024

# TUFFGRIP PS-99

## FIRM-SET MODIFIED TRANSITIONAL PSA

RH	pH	MVER	FLASH TIME	WORKING TIME	CURE TIME	LIGHT TRAFFIC	HEAVY TRAFFIC	ROLLING LOADS
								
99%	5-12	12 lbs	30-60 MIN*	12 HRS	12 HRS	0 MIN*	24 HRS	48 HRS

## APPROVED SUBSTRATES & SURFACES

- APA underlayment grade plywood and OSB
- Association grade particleboard
- Cement backer board
- Cementitious and anhydrite screeds
- Concrete and radiant heated subfloors that do not exceed 85°F (30°C)
- Well-bonded residue from cutback adhesives
- Well-bonded residue from multipurpose, latex, and pressure sensitive adhesives

## WHY USE

- Aggressive tack, fast grabbing
- High moisture tolerance
- High-strength, water-resistant bond
- Elastomeric bond
- Repositionable installation
- Immediate access for light traffic
- Handles heavy rolling loads
- Attractive price point
- Installs multiple flooring types
- 12 hours of working time
- Simple installation
- Plasticizer migration resistance
- Low VOC, extremely low odor
- Antimicrobial technology

## CERTIFICATIONS



**COVERAGE: 90-350 ft<sup>2</sup>/gal**  
**AVAILABLE IN: 1 and 4 gal**  
**SHELF LIFE: 2 years**



### APPROVED FLOORING TYPES

**RESILIENT:** Linoluem, **Modular** (LVP, LVT, woven, rigid core [dryback], SVT, VCT, VET), **Rubber** (crumb, sheet, tile), **Sheet** (fiberglass, heterogeneous, homogeneous), **Stair Treads** (rubber, vinyl) **CARPET:** **Broadloom** (6-ft vinyl-backed, Action-Back, jute-back, double-stick - carpet-to-cushion & cushion-to-substrate, hot-melt-backed, HP- & vinyl-backed, non-vinyl-backed patterned, polyurethane, rubber-backed, unitary & unitary Action-Back, woven-backed), **Modular** (hard-backed, soft-backed, walk-off) **WOOD: Cork** (cork-backed hard surface, underlayment)

**THIS PRODUCT  
DOES NOT  
OFFER MOISTURE  
PROTECTION**

### APPROVED SUBSTRATES & SURFACES

- APA underlayment grade plywood and OSB
- Association grade particleboard
- Cement backer board
- Cementitious and anhydrite screeds
- Concrete and radiant heated subfloors that do not exceed 85°F (30°C)
- Existing well-bonded non-cushion-backed vinyl, tile and sheet flooring
- Fully secured cork underlayments
- Gypsum and lightweight concrete (primed with a universal primer)
- Terrazzo (properly prepared with all waxes and surface finishes removed)

### SUBSTRATE TESTING

**RH** - 99% [ASTM F2170]

**pH** - 5-12 [ASTM F710]

**MVER** - 12 lbs [ASTM F1869]

### PRECAUTIONARY NOTE:

- This product does not form a moisture vapor barrier and will not protect flooring from moisture damage.

### SUBSTRATE & SURFACE PREPARATION

Follow flooring manufacturer's guidelines. Substrate must be prepared per ASTM F710 standards including, but not limited to the following:

- Concrete floors must be dry, clean, smooth and structurally sound. They shall be free of any foreign materials that might prevent adhesive bond, including dust, dirt, solvent, paint, wax, oil, grease, contaminants from sweeping compounds, residual adhesive, adhesive removers, incompatible sealers, fire-retardant chemicals, fungicides, release agents, alkaline salts, excessive carbonation, laitance, mold, mildew, and curing, sealing, hardening or parting compounds.
- Fill all surface cracks, grooves, depressions, control joints and non-moving joints with moisture resistant patching and self-leveling compounds, allow to fully cure and correct high spots before applying adhesive.
- The substrate, adhesive and flooring must be acclimated in an enclosed building with the HVAC operational at service temperature, between 60-95°F (15-35°C), and between 30-65% relative humidity, for at least 72 hours prior to, during, and permanently after installation.
- When installing over radiant heated subfloors, turn the heat off for 24 hours before, during and after installation. Failure to turn the heat off may result in shortened working time of the adhesive. When turning radiant heat back on, raise it incrementally, not to exceed a change of more than 5 degrees per hour to a maximum of 85°F (29°C).

### PRECAUTIONARY NOTES:

- Concrete must be placed in strict accordance with applicable standards and specifications. An intact moisture vapor retarder must be present below the concrete (see ASTM E1745), must be fully cured (at least 45 days), without hydrostatic pressure, without pressurized liquid from any source, and free of surface alkaline salt crystallization.

### APPLICATION INSTRUCTIONS

**Follow flooring manufacturer's guidelines for layout, design and any special precautions for installation.**

1. Spread adhesive using required tools.
2. Install flooring per instructions below dependent upon desired application (flash and working times dependent upon temperature and humidity).





- **Dry-set, PSA** (porous and non-porous substrates)
    - Wait 30-60 minutes after adhesive is spread to allow flash off. Adhesive will darken to visually cue installer.
    - Working time ~12 hours.
  - **Semi-wet set** (porous substrates only)
    - Wait 20-30 minutes after adhesive is spread to allow it to skin over
    - Working time ~20-30 minutes.
  - For sheet vinyl, back-roll the adhesive with an adhesive saturated roller to smooth out the trowel ridges.
3. Roll and cross roll floor with 75-100 lb roller at the end of the installation to ensure proper adhesive transfer.
- Sheet goods - roll from center toward perimeter to expel trapped air.
  - Check flooring after 2 hours and roll again if necessary.

### PRECAUTIONARY NOTES:

- Although this is a high-moisture tolerant adhesive, it does not form a moisture vapor barrier and will not protect flooring from moisture damage.
- Wait 24 hours before heat welding sheet goods.
- Wait 72 hours before wet mopping, or stripping/finishing the floor.
- Reseal lid when not in use to protect product.

### REQUIRED TOOLS AND COVERAGE

\*Trowel dimensions are width X depth X spacing. Coverage is approximate and may vary depending on porosity of substrate and the angle at which the trowel is held.

FLOORING TYPES	TOOL* (IMAGES NOT TO SCALE)		ESTIMATED COVERAGE
<b>BOND ONLY</b>			
<b>RESILIENT: Modular</b> (LVP/LVT [non-porous], SVT, VCT, VET), <b>Sheet</b> (heterogeneous/homogeneous [non-porous]), <b>Stair Treads</b> (rubber/vinyl [non-porous]) <b>CARPET: Modular</b> (hard-backed/soft-backed [non-porous])	1/16" x 1/32" x 1/32" U Notch		220-260 ft <sup>2</sup> /gal
<b>RESILIENT: Linoleum, Modular</b> (LVP/LVT [porous], woven, rigid core [dryback]) <b>Rubber</b> (crumb, sheet, tile), <b>Sheet</b> (heterogeneous/homogeneous [porous]), <b>Stair Treads</b> (rubber/vinyl [porous]) <b>CARPET: Broadloom</b> (6-ft vinyl-backed, double-stick-cushion-to-substrate) <b>Modular</b> (hard-backed/soft-backed [porous], walk-off) <b>WOOD: Cork</b> (cork-backed hard surface, underlayment)	1/16" x 1/16" x 1/16" Sq Notch		150-180 ft <sup>2</sup> /gal
<b>CARPET: Broadloom</b> (Action-Bac, jute-back, hot-melt-backed, HP & vinyl-backed, non-vinyl-backed patterned polyurethane, rubber-backed, unitary Action-Bac)	1/8" x 1/8" x 1/16" V Notch		90-120 ft <sup>2</sup> /gal
<b>CARPET: Broadloom</b> (double-stick - carpet-to-cushion, unitary, woven-backed)	1/8" x 1/8" x 1/16" U Notch		50-65 ft <sup>2</sup> /gal
<b>RESILIENT: Sheet</b> (fiberglass) <b>CARPET: Modular</b> (hard-backed)	3/8" Short Nap Paint Roller		Up to 350 ft <sup>2</sup> /gal

\*It is the sole responsibility of the contractor/installer to determine the proper porosity of the subfloor, apply the correct amount of adhesive for the job conditions and ensure that all instructions, procedures and practices are strictly adhered to.

### CLEANING INSTRUCTIONS

**While product is still wet:** Use a damp cloth and water to remove.

**While product is still soft:** Use denatured alcohol, mineral spirits, or an adhesive remover/stripper. Always check compatibility on a piece of scrap flooring.

### STORAGE

This product should be stored at temperatures between 50-90°F (15-32°C). While this product is freeze-thaw stable, it is necessary to protect it from freezing. Freeze/thaw stable to 10°F (-12°C).

### CAUTION

DO NOT take internally. If swallowed, DO NOT induce vomiting. Call a physician immediately. KEEP OUT OF REACH OF CHILDREN.

### WARRANTY INFORMATION

For warranty information, call Technical Services at 877-238-3225, visit us on the web at [www.my-nfp.com](http://www.my-nfp.com) or e-mail us at [customerservice@nationalflooringproducts.com](mailto:customerservice@nationalflooringproducts.com). Flooring manufacturer's and National Flooring Products written pre-installation and installation instructions must be strictly followed or the National Flooring Products warranty will be void.

### PRODUCT INFORMATION

<b>PRODUCT CHARACTERISTICS</b>	<b>Product Classification</b>	Firm-Set, Modified Transitional Pressure Sensitive* Adhesive
	<b>Base Chemistry</b>	Hybrid acrylic
	<b>Curing Method</b>	Proprietary modified cross-linking
	<b>Appearance/Color</b>	Tan
	<b>Odor</b>	Extremely low
	<b>Consistency</b>	Smooth, medium viscosity liquid
	<b>Application</b>	Easy troweling/rolling
	<b>Flammability</b>	Non-flammable
	<b>Freeze/Thaw</b>	Stable to 10°F (-12°C) [3 cycles]
	<b>Shelf Life</b> [Unopened Container at 70°F]	2 years
<b>TESTING</b>	<b>Moisture Control</b>	No
	<b>RH</b> [ASTM F2170]	99%
	<b>pH</b>	5-12
	<b>MVER</b> [ASTM F1869]	12 lbs
	<b>Porosity</b> [ASTM F3191]	N/A
<b>TIME</b>	<b>Open Time</b>	20-30 min (semi-wet-set)
	<b>Flash Time</b>	30-60 min (PSA)
	<b>Working Time</b>	20-30 min (semi-wet-set); 12 hrs (PSA)
	<b>Cure Time</b>	12 hrs
	<b>Pot Life</b>	N/A
<b>TRAFFIC</b>	<b>Light Traffic</b>	0 min (PSA), 12 hrs (Semi-wet-set)
	<b>Heavy Traffic</b>	24 hrs
	<b>Rolling Loads</b>	48 hrs
<b>ACOUSTICS*</b>	<b>STC</b>	N/A
	<b>IIC</b>	N/A
	<b>Delta IIC</b>	N/A
<b>SUSTAINABILITY</b>	<b>Solvents</b>	No
	<b>Isocyanates</b>	No
	<b>VOC Wet Applied</b> [g/L] [SCAQMD Rule #1168]	< 11 g/L
	<b>Bio-Based Content</b>	Yes
	<b>Post-Consumer Recycled Content</b>	Yes
	<b>Mineral Abundant Content</b>	Yes
	<b>LEED v4/4.1 Points</b>	Contributes to low emitting materials
	<b>Certifications</b>	FloorScore®, Green Label Plus®, GREENGUARD®
<b>Transparency</b>	N/A	
<b>WARRANTY**</b>	<b>Duration</b>	10-Year Performance Warranty
	<b>Coverage</b>	Bond

\*IIC (delta) and STC (delta) ranges are flooring assembly specific based on third party testing and verification in a controlled environment. For any questions or further information, please contact National Flooring Products Technical at 877-238-3225.

\*\*For warranty information, view Product Warranty Certificate.



### APPROVED SUBSTRATES & SURFACES

- APA underlayment grade plywood and OSB
- Association grade particleboard
- Cement backer board
- Concrete and radiant heated subfloors that do not exceed 85°F (30°C)
- Gypsum and lightweight concrete

### SUBSTRATE TESTING

**RH** - 75% [ASTM F2170]

**pH** - NTR 5-14

**MVER** - 5 lbs [ASTM F1869]

**Porosity** - CSP 1+, must pass [ASTM F3191]

### SUBSTRATE AND SURFACE PREPERATION

- All substrates or surfaces must be level, dry, clean, smooth and structurally sound. They shall be free of any foreign materials that might prevent proper absorption, including dust, dirt, solvent, paint, wax, oil, grease, residual adhesive, adhesive removers, incompatible sealers, fire-retardant chemicals, fungicides, release agents, alkaline salts, excessive carbonation, laitance, mold, mildew, and curing, sealing, hardening or parting compounds.
- The substrate or surface and TuffGRIP LSF Primer (and adhesive and flooring if applicable) must be acclimated in an enclosed building with the HVAC operational between 60-95°F, and between 30-65% relative humidity, for at least 72 hours before, during and after the installation.

### PRECAUTIONARY NOTES:

- Concrete must be placed in strict accordance with applicable standards and specifications. An intact moisture vapor retarder must be present below the concrete (see ASTM E1745), must be fully cured (at least 45 days), porous (see ASTM F3191), and without hydrostatic pressure.
- Concrete must be a minimum of 2500 psi and without visible or standing water.

### APPLICATION INSTRUCTIONS

**Follow flooring manufacturer's guidelines for layout, design and any special precautions for installation. READY TO USE, DO NOT DILUTE.**

1. Spread product using required tool.

- Cure time - 30-60 minutes under acceptable temperature and humidity conditions

### PRECAUTIONARY NOTES:

- Allow product to fully cure (dry to the touch) before applying any adhesive over top.
- Reseal lid when not in use to protect product.

### REQUIRED TOOLS AND COVERAGE

\*Trowel dimensions are width X depth X spacing. Coverage is approximate and may vary depending on porosity of substrate and the angle at which the trowel is held.

FLOORING TYPES	TOOL* (IMAGES NOT TO SCALE)		ESTIMATED COVERAGE
<b>PRIMER ONLY</b>			
For use under all glue-down, loose-lay, and floating floors	3/8" Short Nap Paint Roller		300-450 ft <sup>2</sup> /gal

\*It is the sole responsibility of the contractor/installer to determine the proper porosity of the subfloor, apply the correct amount of adhesive for the job conditions and ensure that all instructions, procedures and practices are strictly adhered to.

## CLEANING INSTRUCTIONS

**While product is still wet:** Use a dry cloth immediately to remove any excess adhesive from the surface of the wood.

**While product is still soft:** Use a remover/stripper, denatured alcohol or mineral spirits. Always check compatibility on a piece of scrap flooring.

## STORAGE

This product should be stored at temperatures between 50-90°F (15-32°C). PROTECT FROM FREEZING.

## CAUTION

DO NOT take internally. If swallowed, DO NOT induce vomiting. Call a physician immediately. KEEP OUT OF REACH OF CHILDREN.

## WARRANTY INFORMATION

For warranty information, call Technical Services at 877-238-3225, visit us on the web at [www.my-nfp.com](http://www.my-nfp.com) or e-mail us at [customerservice@nationalflooringproducts.com](mailto:customerservice@nationalflooringproducts.com). Flooring manufacturer's and National Flooring Products written pre-installation and installation instructions must be strictly followed or the National Flooring Products warranty will be void.

### PRODUCT INFORMATION

<b>PRODUCT CHARACTERISTICS</b>	<b>Product Classification</b>	Universal Latex Primer Coating
	<b>Base Chemistry</b>	Acrylic Latex
	<b>Curing Method</b>	Evaporation
	<b>Appearance/Color</b>	Milky-white
	<b>Odor</b>	Extremely low
	<b>Consistency</b>	Liquid
	<b>Application</b>	Easy rolling
	<b>Flammability</b>	Non-flammable
	<b>Freeze/Thaw</b>	Protect from freezing
	<b>Shelf Life</b> [Unopened Container at 70°F]	2 years
<b>TESTING</b>	<b>Moisture Control</b>	No
	<b>RH</b> [ASTM F2170]	75%
	<b>pH</b>	NTR 5-14
	<b>MVER</b> [ASTM F1869]	5 lbs
	<b>Porosity</b> [ASTM F3191]	N/A
<b>TIME</b>	<b>Open Time</b>	N/A
	<b>Flash Time</b>	N/A
	<b>Working Time</b>	N/A
	<b>Cure Time</b>	30-60 min
	<b>Pot Life</b>	N/A
<b>TRAFFIC</b>	<b>Light Traffic</b>	N/A
	<b>Heavy Traffic</b>	N/A
	<b>Rolling Loads</b>	N/A
<b>ACOUSTICS*</b>	<b>STC</b>	N/A
	<b>IIC</b>	N/A
	<b>Delta IIC</b>	N/A
<b>SUSTAINABILITY</b>	<b>Solvents</b>	No
	<b>Isocyanates</b>	No
	<b>VOC Wet Applied</b> [g/L] [SCAQMD Rule #1168]	0 g/L
	<b>Bio-Based Content</b>	No
	<b>Post-Consumer Recycled Content</b>	No
	<b>Mineral Abundant Content</b>	No
	<b>LEED v4/4.1 Points</b>	Contributes to low emitting materials
	<b>Certifications</b>	FloorScore®, Green Label Plus®, GREENGUARD®
<b>Transparency</b>	N/A	
<b>WARRANTY**</b>	<b>Duration</b>	10-Year Performance Warranty
	<b>Coverage</b>	Product Performance

\*IIC (delta) and STC (delta) ranges are flooring assembly specific based on third party testing and verification in a controlled environment. For any questions or further information, please contact National Flooring Products Technical at 877-238-3225.

\*\*For warranty information, view Product Warranty Certificate.



## **INSTALLATION | MAINTENANCE | WARRANTY**

For the most accurate and updated information, please check our online version at [www.my-nfp.com](http://www.my-nfp.com).